

Smart Controller

智慧型面板



復歸鍵 停止鍵 啟動鍵

Power Indicator 電源指示燈
Stop Indicator 停止指示燈
Start Indicator 運轉指示燈
Stand-by Indicator 備機指示燈
Overload Indicator
O.L 電流過負載指示燈
Low oil Pressure Indicator
A.1 失油保護指示燈
Remote-control Indicator
R/L 遠端操作指示燈

- The distinctive and high efficient design enable to eliminate wearing damages to all mechanical parts during ON/OFF and loading / unloading operations. 特殊的設計，在空車啟動與空車停機時降低磨擦阻力對機械的傷害。
- The user friendly control system can monitor exactly the running conditions of the remote compressors. 本機、遠端彈性化操控，選擇更人性化。
- Intelligent control system is able to self-adjust to execute automatic or semi-automatic control mode. 智慧型自動控制，可自動調節為全自動或半自動操作模式。
- Multiple protective system and intimate design to completely meet customers' requirements. 貼心設計，多重保護控制系統功能。
- Simple and visible indicator lights. 操控面板指示燈顯示運轉狀態。

Compressed Air Cleaning System

空氣清淨化系統

Features

- Comprehensive range of filters to meet requirements from different industrial users.
- We supply different grade of air filtrating systems to meet various applications.

特點

- 配合不同工業用戶需求，提供各種樣式過濾器組合。
- 因應客戶不同的用途，不同的清淨化需求，提供不同等級的過濾系統。

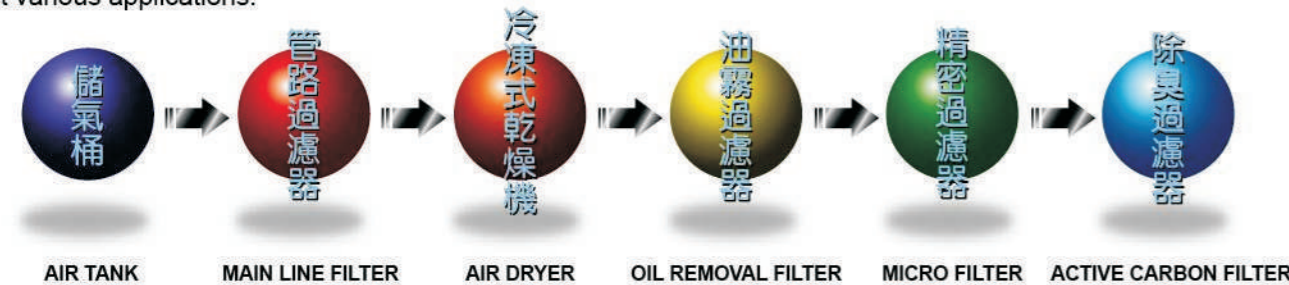

Recommended Air Combination 標準組合選配表

Item 項目	Model 型式	SVU-205N	SWU-307N SWU-310N	SWU-415N	Specs. 規格	Model 型式	SDE-4E	SDE-8E	SDE-11E
Main Line Filter 管路過濾器	---	---	---	ARF 15A	Flow Rate(m ³ /min) 處理量		0.6	1.2	1.6
Air Dryer 冷凍式乾燥機		SDE-4E	SDE-8E	SDE-11E	Dew Point 出口露點		3~15°C		
Oil Removal Filter 油霧過濾器		ARB 04A	ARB 08A	ARB 15A	Inlet Temp 入口溫度		Max.80°C		
Micro Filter 精密過濾器		ARA 04A	ARA 08A	ARA 15A	Ambient Temp 環境溫度		2~43°C		
					W.P.(bar) 工作壓力		2~10		
					In/Out 管徑		1/2"∅	3/4"∅	1"∅
					Power 電源		1	1	1
					Type of Refrigerant 冷媒型式		R-134A	R-134A	R-407C
					L(mm) 長		254	254	244
					Size W(mm) 尺寸 寬		722	722	797
					H(mm) 高		515	515	626
					Weight(kg) 重量		34	34	40
					Applicable Ranges(hp) 適用馬力		5	5~10	10~15



※Standard products supplied with 220V, and refer to us for the different voltage or higher capacity and urgent delivery.

※Keep on searching for excellence, we reserve the right to alter specifications without prior notice.

※標準電壓220V，異電壓部份與處理量較大之規範或交期請洽本公司。

※本公司不斷研究改進，規格如有變更，恕不另行通知。

5~15HP Excellent Efficiency Superior Performance

運轉高效率
實用高性能

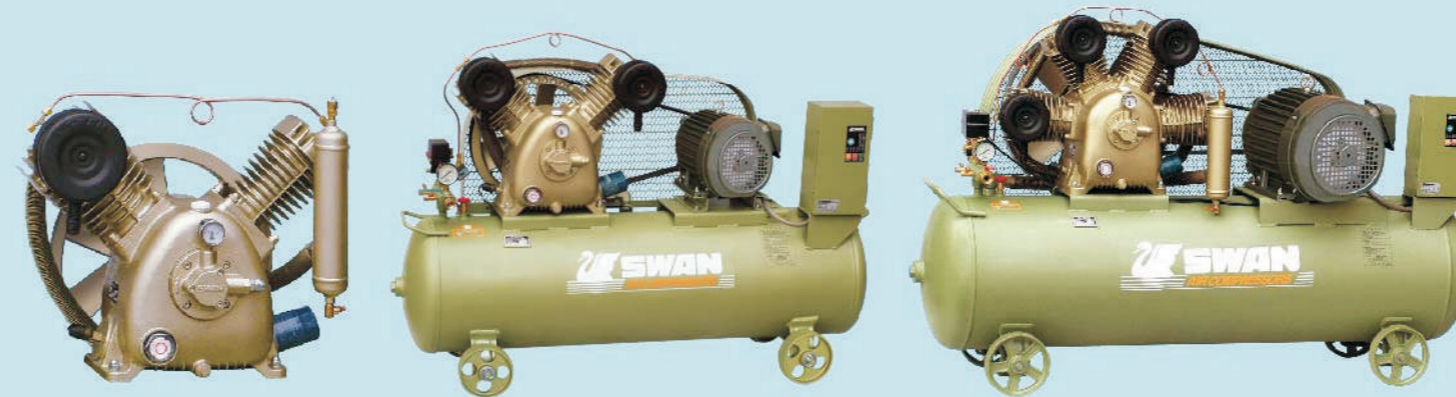

N TYPE Series Air Cooled Piston Compressors

系列空氣壓縮機

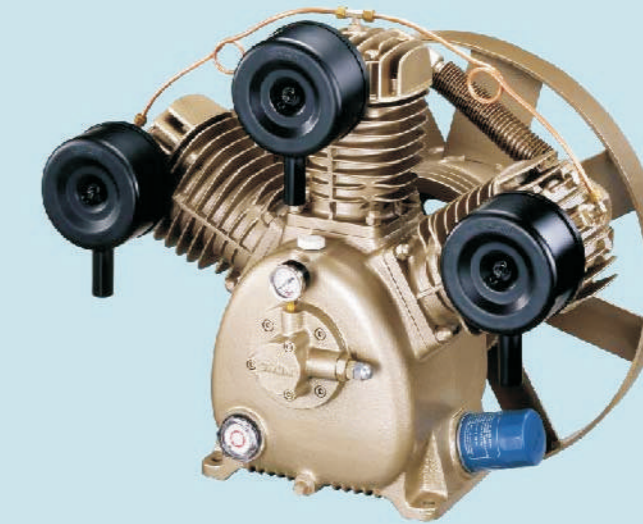

Innovation, Automatic Control, Easy Maintenance

創新、自動控制與簡易維修



Since 1956

www.swanair.com.tw



東正鐵工股份有限公司
 TONG CHENG IRON WORKS CO., LTD.
 公司：台中市東區信義街116號
 TEL:886-4-2261-2135 FAX:886-4-2261-5465
 廠址：台中市南區大慶街二段16號
 TEL:886-4-2261-2135 FAX:886-4-2262-8246

台北營業所：新北市五股區五權五路43號
 TEL:02-2299-1285 FAX:02-2298-2296
 台中營業所：台中市南區大慶街二段16號
 TEL:04-2261-2135 FAX:04-2261-5465
 台南營業所：台南市永康區中正南路635號
 TEL:06-253-9848 FAX:06-253-9849

Head Office:
 No.16, Ta Chin St. Sec. 2, Taichung, Taiwan
 TEL:886-4-2261-2135 FAX:886-4-2262-8246
 Reg. Office:
 116, Shing Yee St., Taichung, Taiwan
 TEL:886-4-2261-2135 FAX:886-4-2261-5465



TC201708AB

Special Features of Swan's N TYPE Compressors

N TYPE 獨家專利與強制式潤滑系統特點

Full combination of professional and unique technical design to lubricate all running parts inside the pump with enforced clean oil.

- Special oil carried inside the crankshaft to ensure sufficient and clean lubrication
- Built-in enforced lubricating system to guarantee full lubrication without failure.
- Long-last oil filter and oil capillary pipes to ensure the supply of clean oil.

專業與技術的極致，潔淨強制潤滑機構

- 特殊貯油式曲軸設計，即時得到充分的潔淨潤滑。
- 內藏型強制潤滑系統，簡潔確實，確保充分潤滑的有效性。
- 長效性的潤滑油過濾器與曲軸的導油管設計，確保潤滑油的潔淨。

Well Spread Oil Film

強均勻潔淨的油膜

Oil Pressure Gauge

潤滑油壓力錶

Provide Immediate Lubrication

With lubricant being always kept and pumped throughout the whole lubricating system.

即時提供潤滑油

預藏型曲軸設計，儲存潤滑油。

Oil Pump

Greatly reducing oil consumption by supplying appropriate lubricant.

潤滑油幫浦

提供適量適壓之潤滑油，減少潤滑油消耗量。

High Efficient Valve Assy

高效率進排氣閥組

Precise Oil Pressure Switch

Oil alert — avoid any possibility of the compressor being blocked due to failure in lubricating.

精確的失油開關

失油開關保護，免束心之處。

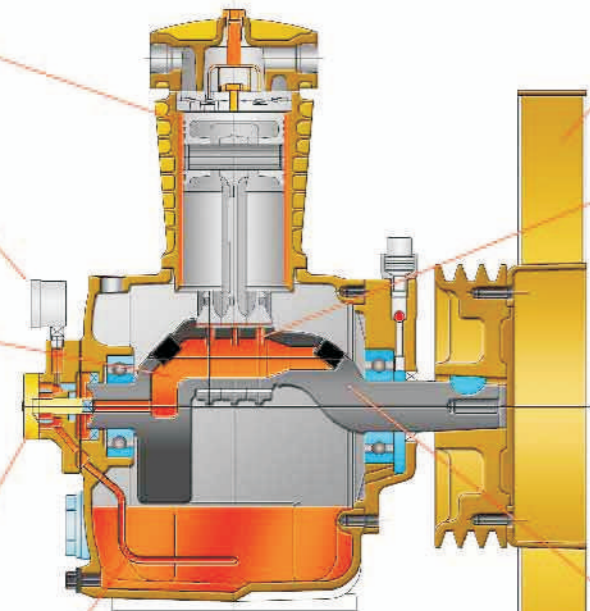

Simple And Concise Appearance

With built-in lubricating mechanism.

造型簡潔

內藏型潤滑機構，外型簡潔美觀。



SVU-205N

Powerful Cooling Fan

強力散熱風扇

Oil Capillary Pipe

To provide clean lubricants. Equipped with oil filter and guide-piping to extend the service life of running parts.

導油管設計

提供潔淨潤滑油，增設過濾器與導油管，防止污物磨損機件。

Enforced-lubrication Crankshaft

強制潤滑型曲軸



SWU-310N

Long-lasting Oil Filter

Ensure clean lubricating oil by equipping with oil filter.

長效性潤滑油過濾系統設有過濾裝置，提供潔淨潤滑油。

Crankcase With Ample Oil reservoir Design

曲軸箱具有大型儲油槽設計。

Unique Components and Mechanism

獨特零組件與機械設計



Product quality guaranteed through the application of modern technology such as CAD-CAM software, that are widely used in all areas from product development, modeling and design, to the manufacturing process. 以CAD-CAM進行分析、模擬、設計、製造、品質的發展從設計開始。



Highly efficient and durable valve assemblies are produced through the use of special heat treatments and high precision grinding processes.

經熱處理及精密研磨的進排氣閥組，注意每環節確保效率與壽命。



All compressor surfaces and air tanks are prepared by initially shot blasting, followed by the application of powder coating to ensure bright, durable and environmentally friendly surface protection. 鋼珠噴砂處理，自動粉體塗裝；注重環保並確保外觀晶亮耐久。

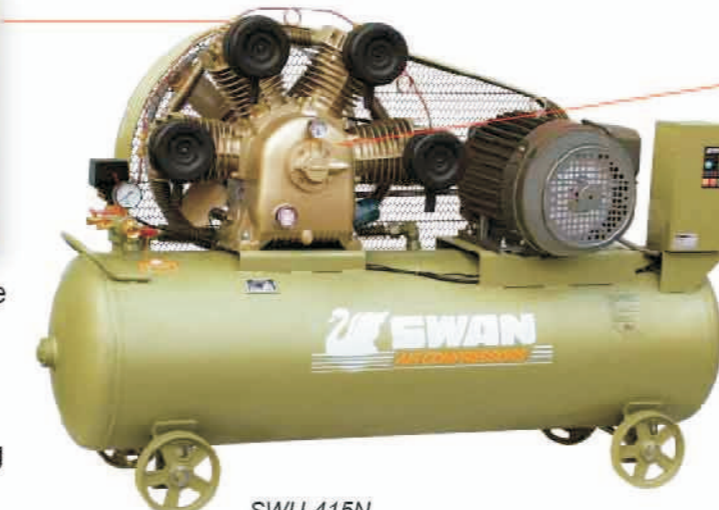

SWU-415N



High quality and consistent components are manufactured through machining centers which typically are capable of completing a finished surface in a single set-up.

以大型自動加工中心機進行精密加工，一次夾持完成各加工面，確保精度一致性。

Compressor Pumps

壓縮機機體

SWAN is dedicated to providing a full products line and to satisfy diverse customers' needs.

“堅持品質、不斷創新、永續服務”
是SWAN對客戶支持的回報，也是對客戶不變的承諾！



HVU-205N

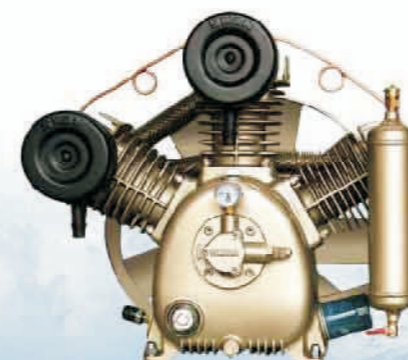

HWU-307N
HWU-310N

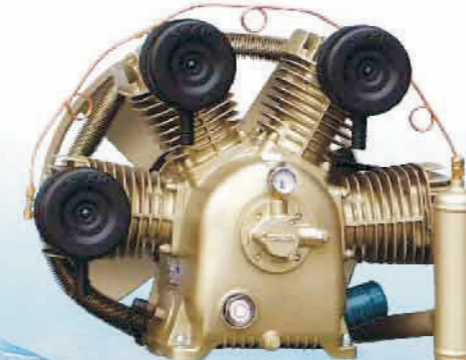

HWU-415N

N Series

N系列 氣冷移動式

SWAN air compressors has been devoting to the development, production and rigorous quality control of all types of air compressors since its establishment in 1956. SWAN air compressors are used in a wide range of industries and get well-known reputation of high quality, reliability and durability.

1956年成立以來，SWAN以豐富的經驗、精進的技術、持續的研究，生產好品質、高可靠、長耐用的空氣壓縮機，獲得客戶的滿意與支持，並依客戶需求提供ODM/OEM特製產品。



SVU-205N



SWU-310N



HVU-205N



HWU-415N

Model 型號	Specs 規格		Working Pressure (kg/cm ² g) 使用壓力	Speed (r.p.m) 轉速		F.A.D. (l/min) 實際排氣量		Tank Capacity (liter) 儲氣桶容量	Compressor Pumps Physical Dimensions 機體實體尺寸		Compressor Units Physical Dimensions 整台實體尺寸	
	馬力	hp		50HZ	60HZ	50HZ	60HZ		LxWxH(mm)	重量(kg)	LxWxH(mm)	重量(kg)
SVU-205N	3.7	5	8	516	620	450	545	155	560x400x450	70	1400x520x980	182
SWU-307N	5.5	7.5		706	850	723	872	240	650x460x550	93	1470x650x1150	243
SWU-310N	7.5	10		706	850	955	1151	300	700x460x560	95	1835x650x1200	263
SWU-415N	11	15	706	850	1229	1480	300	700x520x550	118	1835x650x1200	290	
HVU-205N	3.7	5	16	750	900	338	406	237	560x400x450	70	1470x650x1150	239
HWU-307N	5.5	7.5		706	850	503	606	237	650x460x550	93	1470x650x1150	273
HWU-310N	7.5	10		706	850	652	786	237	700x460x550	95	1470x650x1150	275
HWU-415N	11	15	12	706	850	929	1120	300	700x520x550	118	1835x650x1200	365
HWU-307NH	5.5	7.5	30	560	700	277	346	310	700x450x560	94	1850x650x1160	273
HWU-310NH	7.5	10		560	700	371	464	310	700x450x560	95	1850x650x1160	275

* Keep on developing for excellence, we reserve the right to alter specifications without prior notice. * 本公司不斷研究改進，規格如有變更，恕不另行通知。
* Other special air discharge quantity, pressure and drive type are available upon request. * 規格外之壓力、排氣量、空壓設備，詳細資料歡迎與本公司洽詢。